

JVC

SERVICE MANUAL

COLOR TELEVISION

AV-20N11 /PH
AV-20N31 /PH

BASIC CHASSIS

GA2

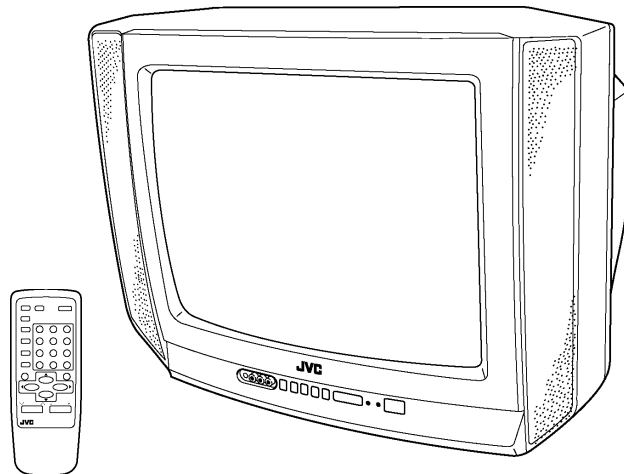

CONTENTS

■ SPECIFICATIONS	2
■ SAFETY PRECAUTIONS	3
■ FEATURES	4
■ MAIN DIFFERENCE LIST	4
■ SPECIFIC SERVICE INSTRUCTIONS	4
■ SERVICE ADJUSTMENTS	10
■ PARTS LIST	29
★ STANDARD CIRCUIT DIAGRAM (APPENDIX)	2-1
★ OPERATING INSTRUCTIONS	

SPECIFICATIONS

Items		Contents	
		AV-20N11	AV-20N31
Dimensions (W × H × D)		619mm × 458mm × 488mm	←
Mass		19.0kg	←
TV RF System		CCIR (M)&(N)	←
Color / Sound System		NTSC / PAL-M / PAL-N	NTSC / PAL-M / PAL-N BTSC (Multi Channel Sound)
TV Receiving Channels and Frequency		VL Band (02~06) 54MHz~88MHz VH Band (07~13) 174MHz~216MHz UHF Band (14~69) 470MHz~806MHz	←
CATV Receiving Channels and Frequency	Low Band (02~06) High Band (07~13) Mid Band (14~22) Super Band (23~36) Hyper Band (37~64) Ultra Band (65~94, 100~125) Sub Mid Band (01, 96~99)	(54MHz~804MHz)	←
TV/CATV Total Channel		180 Channels	←
Intermediate Frequency	Video IF Carrier	45.75MHz	←
	Sound IF Carrier	41.25MHz (4.5MHz)	←
Color Sub Carrier		NTSC : 3.579545MHz PAL-M : 3.57561149MHz PAL-N : 3.58205625MHz	←
Antenna terminal		75 Ω (VHF/UHF) Terminal, F-Type Connector	←
Power Input		Rated Voltage : 110V~240V AC, 50Hz/60Hz Operating Voltage : 90V~260V AC, 50Hz/60Hz	←
Power Consumption		60W	←
Picture Tube (measured diagonally)		Picture tube 52cm / Visible area 48cm	←
High Voltage		25.5kV ± 1.0kV (at zero beam current)	←
Speaker		5cm × 12cm Oval type × 2	←
Audio Power Output		2W (monaural)	1.5W+1.5W (stereo)
Input	Video input	1Vp-p 75 Ω (RCA pin jack)	←
	Audio input	500mVrms (-4dBs) / High impedance (RCA pin jack)	
Output	Video output	1Vp-p 75 Ω (RCA pin jack)	←
	Audio output	500mVrms (-4dBs) / Low impedance (RCA pin jack)	
Headphone Jack		Stereo mini Jack (dia. 3.5mm, Sound is monaural)	Stereo mini jack (dia. 3.5mm, Sound is stereo)
Remote Control Unit		RM-C372GY (AA/R6/UM-3 battery × 2)	RM-C373GY (AA/R6/UM-3 battery × 2)

Design & specifications are subject to change without notice.

SAFETY PRECAUTIONS

- The design of this product contains special hardware, many circuits and components specially for safety purposes. For continued protection, no changes should be made to the original design unless authorized in writing by the manufacturer. Replacement parts must be identical to those used in the original circuits. Service should be performed by qualified personnel only.
- Alterations of the design or circuitry of the products should not be made. Any design alterations or additions will void the manufacturer's warranty and will further relieve the manufacturer of responsibility for personal injury or property damage resulting therefrom.
- Many electrical and mechanical parts in the products have special safety-related characteristics. These characteristics are often not evident from visual inspection nor can the protection afforded by them necessarily be obtained by using replacement components rated for higher voltage, wattage, etc. Replacement parts which have these special safety characteristics are identified in the parts list of Service manual. **Electrical components having such features are identified by shading on the schematics and by (Δ) on the parts list in Service manual.** The use of a substitute replacement which does not have the same safety characteristics as the recommended replacement part shown in the parts list of Service manual may cause shock, fire, or other hazards.
- Don't short between the LIVE side ground and ISOLATED (NEUTRAL) side ground or EARTH side ground when repairing.**
Some model's power circuit is partly different in the GND. The difference of the GND is shown by the LIVE : (\perp) side GND, the ISOLATED(NEUTRAL) : (↯) side GND and EARTH : (\oplus) side GND. Don't short between the LIVE side GND and ISOLATED(NEUTRAL) side GND or EARTH side GND and never measure with a measuring apparatus (oscilloscope etc.) the LIVE side GND and ISOLATED(NEUTRAL) side GND or EARTH side GND at the same time.
If above note will not be kept, a fuse or any parts will be broken.
- If any repair has been made to the chassis, it is recommended that the B1 setting should be checked or adjusted (See ADJUSTMENT OF B1 POWER SUPPLY).
- The high voltage applied to the picture tube must conform with that specified in Service manual. Excessive high voltage can cause an increase in X-Ray emission, arcing and possible component damage, therefore operation under excessive high voltage conditions should be kept to a minimum, or should be prevented. If severe arcing occurs, remove the AC power immediately and determine the cause by visual inspection (incorrect installation, cracked or melted high voltage harness, poor soldering, etc.). To maintain the proper minimum level of soft X-Ray emission, components in the high voltage circuitry including the picture tube must be the exact replacements or alternatives approved by the manufacturer of the complete product.
- Do not check high voltage by drawing an arc. Use a high voltage meter or a high voltage probe with a VTVM. Discharge the picture tube before attempting meter connection, by connecting a clip lead to the ground frame and connecting the other end of the lead through a 10k Ω 2W resistor to the anode button.
- When service is required, observe the original lead dress. Extra precaution should be given to assure correct lead dress in the high voltage circuit area. Where a short circuit has occurred, those components that indicate evidence of overheating should be replaced. Always use the manufacturer's replacement components.

9. Isolation Check

(Safety for Electrical Shock Hazard)

After re-assembling the product, always perform an isolation check on the exposed metal parts of the cabinet (antenna terminals, video/audio input and output terminals, Control knobs, metal cabinet, screwheads, earphone jack, control shafts, etc.) to be sure the product is safe to operate without danger of electrical shock.

(1) Dielectric Strength Test

The isolation between the AC primary circuit and all metal parts exposed to the user, particularly any exposed metal part having a return path to the chassis should withstand a voltage of 3000V AC (r.m.s.) for a period of one second.

(. . . . Withstand a voltage of 1100V AC (r.m.s.) to an appliance rated up to 120V, and 3000V AC (r.m.s.) to an appliance rated 200V or more, for a period of one second.)

This method of test requires a test equipment not generally found in the service trade.

(2) Leakage Current Check

Plug the AC line cord directly into the AC outlet (do not use a line isolation transformer during this check.). Using a "Leakage Current Tester", measure the leakage current from each exposed metal part of the cabinet, particularly any exposed metal part having a return path to the chassis, to a known good earth ground (water pipe, etc.). Any leakage current must not exceed 0.5mA AC (r.m.s.).

However, in tropical area, this must not exceed 0.2mA AC (r.m.s.).

● Alternate Check Method

Plug the AC line cord directly into the AC outlet (do not use a line isolation transformer during this check.). Use an AC voltmeter having 1000 ohms per volt or more sensitivity in the following manner. Connect a 1500 Ω 10W resistor paralleled by a 0.15 μ F AC-type capacitor between an exposed metal part and a known good earth ground (water pipe, etc.). Measure the AC voltage across the resistor with the AC voltmeter. Move the resistor connection to each exposed metal part, particularly any exposed metal part having a return path to the chassis, and measure the AC voltage across the resistor. Now, reverse the plug in the AC outlet and repeat each measurement. Any voltage measured must not exceed 0.75V AC (r.m.s.). This corresponds to 0.5mA AC (r.m.s.).

However, in tropical area, this must not exceed 0.3V AC (r.m.s.). This corresponds to 0.2mA AC (r.m.s.).

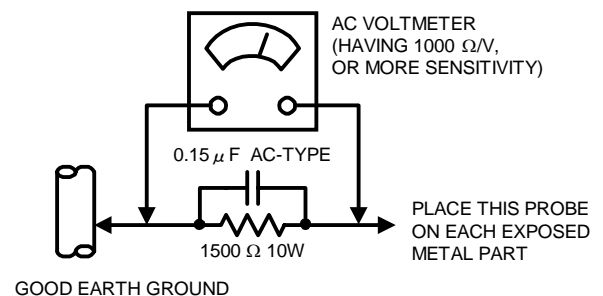

FEATURES

- New chassis design enables use of a main board with simplified circuitry.
- Provided with miniature tuner (TV/CATV).
- PLL synthesizer system TV/CATV totaling 180 channels.
- Multifunctional remote control permits picture adjustment.
- With NTSC/PAL-M & PAL-N color/sound system.
- Adoption of the VIDEO STATUS function.
- With 75Ω V/U in common (F-Type) ANT Terminal.
- Wide range voltage (90V~260V) AC power input.
- Closed-caption broadcasts can be viewed. (AV-20N31)

MAIN DIFFERENCE LIST

△	Symbol No.	Model		Remarks
		Part name	AV-20N11	
		MAIN PWB ASS'Y	SGA-1057A-H2	SGA-1054A-H2
△		FRONT CABINET	LC10438-020A-HK	LC10438-021A-HK
		TERMINAL SHEET	LC30819-002A	LC30819-001A
	SP01/02	SPEAKER	CEBSS12D-07KJ2	CEBSS12D-04KJ2 (x2)
△		RATING LABEL	GG20003-016A-H	GG20003-017A-H
		PACKING CASE	GG10057-009A-P	GG10057-010A-P
		REMOCON UNIT	RM-C372GY-1H	RM-C373GY-1H
		POS LABEL	CP30902-064(R)	CP30902-065(R)

SPECIFIC SERVICE INSTRUCTIONS

DISASSEMBLY PROCEDURE

REMOVING THE REAR COVER

1. Unplug the power supply cord.
 2. Remove the 6 screws marked (A) and 2 screws marked (B) as shown in Fig.1.
 3. Withdraw the REAR COVER toward you.
- When reinstalling the rear cover, carefully push it inward after inserting the MAIN PWB into the rear cover groove.

REMOVING THE MAIN PW BOARD

- After removing the rear cover.
1. Slightly raise the both sides of the MAIN PW Board by hand and withdraw the MAIN PW Board backward.
(If necessary, take off the wire clamp, connector etc.)

REMOVING THE SPEAKER

- After removing the rear cover.
1. Remove the 2 screws marked (C) as shown in Fig.1.
 2. Follow the same steps when removing the other hand speaker.

CHECKING THE MAIN PW BOARD

1. To check the backside of the MAIN PW Board.
 - 1) Pull out the MAIN PWB. (Refer to REMOVING THE MAIN PWB).
 - 2) Erect the chassis vertically so that you can easily check the backside of the MAIN PW Board.

[CAUTION]

- When erecting the MAIN PWB, be careful so that there will be no contacting with other PW Board.
- Before turning on power, make sure that the CRT earth wire and other connectors are properly connected.

WIRE CLAMPING AND CABLE TYING

1. Be sure clamp the wire.
2. Never remove the cable tie used for tying the wires together.
Should it be inadvertently removed, be sure to tie the wires with a new cable tie.

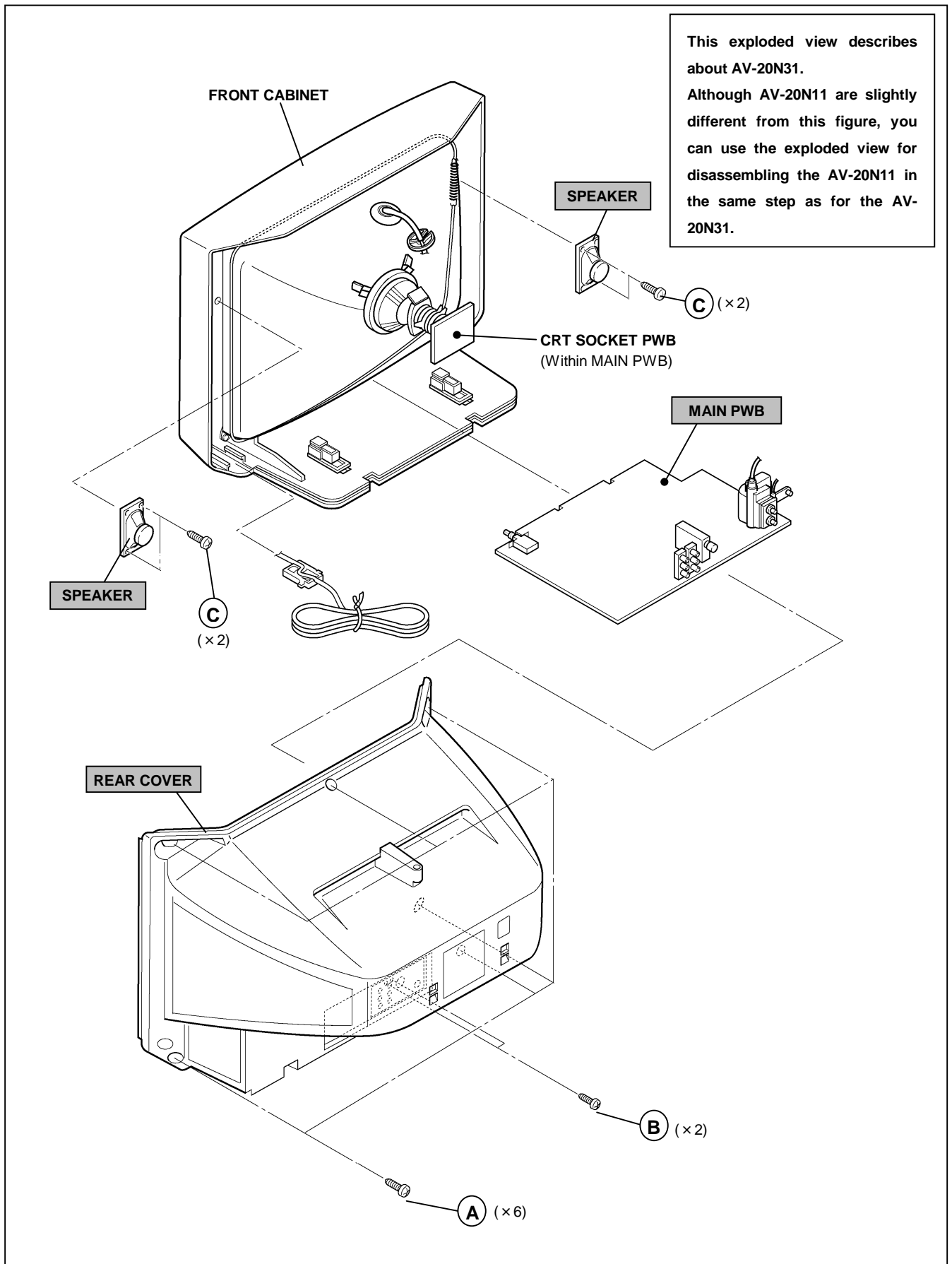

Fig. 1

MEMORY IC REPLACEMENT

1. Memory IC

This model uses a memory IC.
The memory IC stores data for proper operation of video and deflection circuits.
When replacing, be sure to use an IC containing this (initial value) data.

2. Memory IC replacement procedure

(1) Power off

Switch off the power and disconnect the power cord from the wall outlet.

(2) Replace the memory IC.

Be sure to use memory ICs written with the initial data values.

(3) Power on

Connect the power cord to the wall outlet and switch on the power.

(4) System constant check and setting

- 1) Simultaneously press the DISPLAY key and VIDEO STATUS key of the remote control unit.
- 2) The SERVICE MENU screen of Fig.1 is displayed.
- 3) While the SERVICE MENU is displayed, again simultaneously press the DISPLAY and VIDEO STATUS keys to display the Fig.2 SYSTEM CONSTANT screen.
- 4) Refer to the SYSTEM CONSTANT table and check the setting items. Where these differ, select the setting item with the MENU UP / DOWN key and adjust the setting with the MENU LEFT / RIGHT keys. (The letters of the selected item are displayed in yellow.)
- 5) After adjusting, release the MENU LEFT / RIGHT key to store the setting value.
- 6) Press the EXIT key twice to return the normal screen.

(5) Receive channel setting

Refer to the OPERATING INSTRUCTIONS (USER'S GUIDE) and set the receive channels (Channels Preset) as described.

(6) User settings

Check the user setting items according to Table 2.
Where these do not agree, refer to the OPERATING INSTRUCTIONS (USER'S GUIDE) and set the items as described.

(7) SERVICE MENU setting

Verify what to set in the SERVICE MENU, and set whatever is necessary. (Fig.1) Refer to the SERVICE ADJUSTMENT for setting.

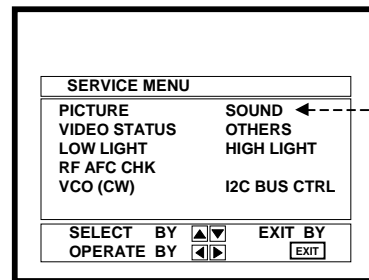

Fig.1

(AV-20N31 Only)

NAME OF REMOTE CONTROL KEYS

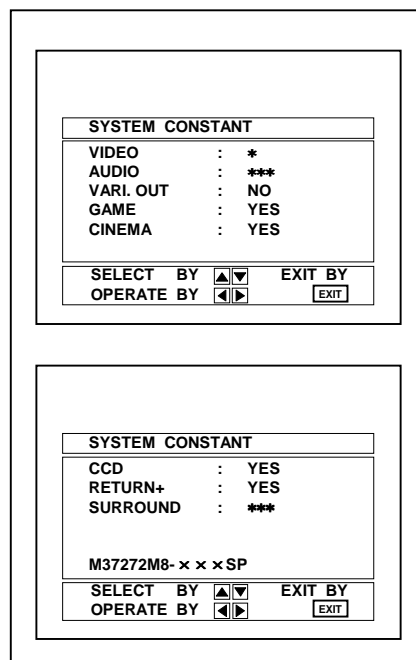
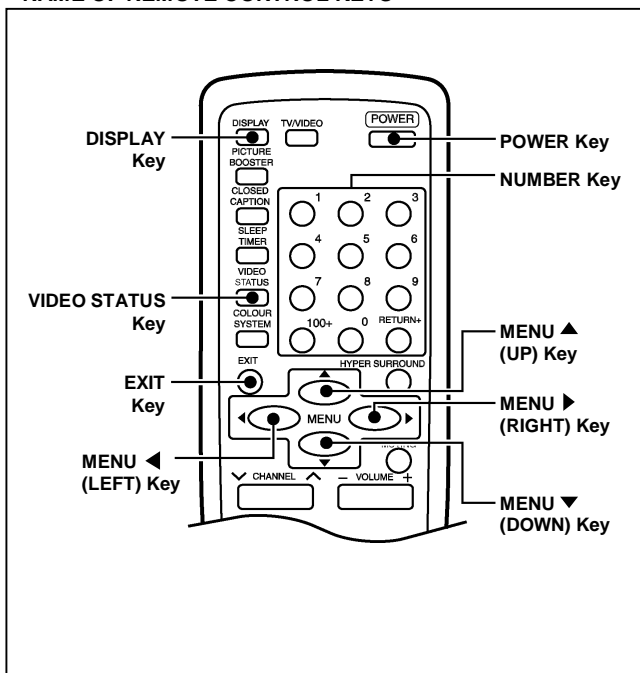

Fig.2

TABLE 1(System Constant Setting)

Setting item	Setting content	Setting value	
		AV-20N11	AV-20N31
VIDEO	<input type="checkbox"/> 1 <input type="checkbox"/> 2	1	2
AUDIO	<input type="checkbox"/> MONO <input type="checkbox"/> MONO <input type="checkbox"/> MTS	MONO	MTS
VARI. OUT	<input type="checkbox"/> YES <input type="checkbox"/> NO	NO	NO
GAME	<input type="checkbox"/> YES <input type="checkbox"/> NO	YES	YES
CINEMA	<input type="checkbox"/> YES <input type="checkbox"/> NO	YES	YES
CCD	<input type="checkbox"/> YES <input type="checkbox"/> NO	YES	YES
RETURN+	<input type="checkbox"/> YES <input type="checkbox"/> NO	YES	YES
SURROUND	<input type="checkbox"/> YES <input type="checkbox"/> NO	NO	YES

TABLE 2 (User setting value)

Setting item	Setting value
● Setting of FUNCTION	
MAIN POWER	OFF
SUB POWER	ON
CHANNEL	CH 02 (AIR)
PICTURE BOOSTER	OFF
VOLUME	10
TV/VIDEO	TV
CAPTION	OFF (CC1/T1)
DISPLAY	POSITION INDICATION
SLEEP TIMER	0
VIDEO STATUS	STANDARD
HYPER SURROUND	OFF [AV-20N31 Only]
COLOUR SYSTEM	AUTO PAL
● Setting of MENU	
TINT	STANDARD
COLOR	STANDARD
PICTURE	STANDARD
BRIGHT	STANDARD
DETAIL	STANDARD
BASS	CENTER <input type="checkbox"/>
TREBLE	CENTER <input type="checkbox"/> [AV-20N31 Only]
BALANCE	CENTER <input type="checkbox"/>
MTS	STEREO <input type="checkbox"/>
SET CLOCK	Unnecessary to set (000).
ON/OFF TIMER	NO
CHANNEL SUMMARY	See Operation Manual
NOISE MUTING	OFF
BACK GROUND	BLACK
LANGUAGE	ENG.
CLOSED CAPTION	CC1 / T1:OFF(At Packing)

TABLE 3 (Service menu setting items)

Service menu	Setting item	Service menu	Setting item
PICTURE	1. PICTURE		54. H POS. 60
	2. BRIGHT		55. H BLK. 60 Do not adjust.
	3. COL.PALM		56. V POS. 60
	4. COL.PALN		57. V SIZE60
	5. COL.NTSC		58. V S CR60
	6. TINT		59. V LIN. 60
	7. TV DTL	Do not adjust.	60. RF AGC
	8. EXT PIC.		
	9. EXT BRI		SOUND
	10. EXT COL.		(AV-20N31 ONLY)
	11. EXT TINT		1. NOISE
	12. EXT DTL		2. IN LEVEL
	13. PIN KILL		3. FH MON. Do not adjust.
	14. YS CONT		4. ST VCO
	15. TV Y-DL		5. PILOT
	16. EXT Y-DL		6. FILTER
	17. WPL SW		7. LOW SEP.
	18. Y GAMMA		8. HI SEP.
	19. P/N GP.		9. 5FH MON.
	20. COL. L SW		10. SAP VCO
	21. COL. LMT.		11. IN GAIN Do not adjust.
	22. PN C. ATT		12. FIL. OFF.
	23. OFST. SW		VIDEO STATUS
	24. OFST. B-Y		TINT
	25. OFST. R-Y		COLOR
	26. C-TOF SW		PICTURE
	27. TV T FO Do not adjust.		BRIGHT
28. TV T Q	DETAIL		
29. EXT T FO	G DRIVE Do not adjust.		
30. EXT T Q	B DRIVE		
31. C-TRAP	R CUT.		
32. C-TR. FO	G CUT.		
33. C-TRAP Q	B CUT.		
34. FIX B/W	OTHERS		
35. APA P. FO	1. OSD HP		
36. DC TRAN.	2. OSD VP Do not adjust.		
37. B. ST. SW	3. H-CK SW		
38. B. ST. PO.	LOW LIGHT		
39. ABL GAIN	R CUT OFF		
40. ABL PO.	G CUT OFF		
41. HALF T.	B CUT OFF		
42. DRV G SW	HIGH LIGHT		
43. NT. COMB	G DRIVE		
44. COIN DET	B DRIVE		
45. NOISE L.	RF AFC CHK		
46. VCD MODE	RF AFC		
47. V AGC SP	FINE Do not adjust.		
48. H POS. 50	VCO (CW)		
49. H BLK. 50 Do not adjust.	IF VCO (CW)		
50. V POS. 50	(adjustment mode)		
51. V SIZE50	I²C BUS CTRL		
52. V S CR50	I ² C BUS		
53. V LIN. 50	(Fixed to ON state.)		

REPLACEMENT OF CHIP COMPONENT

■ CAUTIONS

1. Avoid heating for more than 3 seconds.
2. Do not rub the electrodes and the resist parts of the pattern.
3. When removing a chip part, melt the solder adequately.
4. Do not reuse a chip part after removing it.

■ SOLDERING IRON

1. Use a high insulation soldering iron with a thin pointed end of it.
2. A 30w soldering iron is recommended for easily removing parts.

■ REPLACEMENT STEPS

1. How to remove Chip parts

◆ Resistors, capacitors, etc.

- (1) As shown in the figure, push the part with tweezers and alternately melt the solder at each end.

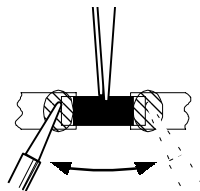

- (2) Shift with tweezers and remove the chip part.

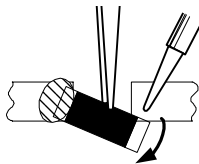

◆ Transistors, diodes, variable resistors, etc.

- (1) Apply extra solder to each lead.

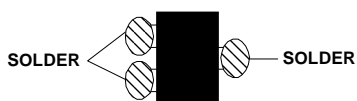

- (2) As shown in the figure, push the part with tweezers and alternately melt the solder at each lead. Shift and remove the chip part.

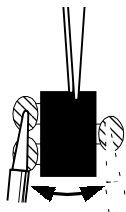

Note : After removing the part, remove remaining solder from the pattern.

2. How to install Chip parts

◆ Resistors, capacitors, etc.

- (1) Apply solder to the pattern as indicated in the figure.

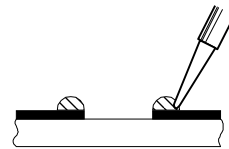

- (2) Grasp the chip part with tweezers and place it on the solder. Then heat and melt the solder at both ends of the chip part.

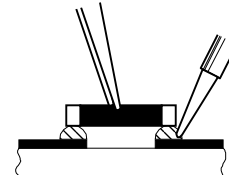

◆ Transistors, diodes, variable resistors, etc.

- (1) Apply solder to the pattern as indicated in the figure.
- (2) Grasp the chip part with tweezers and place it on the solder.
- (3) First solder lead **A** as indicated in the figure.

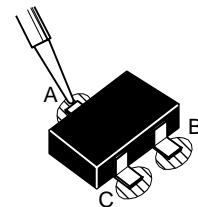

- (4) Then solder leads **B** and **C**.

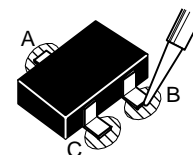

SERVICE ADJUSTMENTS

ADJUSTMENT PREPARATION:

1. You can make the necessary adjustments for this unit with either the remote control unit or with the adjustment equipment and parts as given below.
2. Adjustment with the remote control unit is made on the basis of the initial setting values, however, the new setting values which set the screen to its optimum condition may differ from the initial settings.
3. Make sure that AC power is turned on correctly.
4. Turn on the power for the set and test equipment before use, and start the adjustment procedures after waiting at least 30 minutes.
5. Unless otherwise specified, prepare the most suitable reception or input signal for adjustment.
6. Never touch any adjustment parts, which are not specified in the list for this adjustment-variable resistors, transformers, condensers, etc.
7. Presetting before adjustment.

Unless otherwise specified in the adjustment instructions, preset the following functions with the remote control unit.

VIDEO STATUS	STANDARD
BASS, TREBLE, BALANCE	CENTER
TINT, COLOR, PICTURE, BRIGHT, DETAIL	STANDARD

ADJUSTMENT EQUIPMENT

1. DC voltmeter(or digital voltmeter)
2. Oscilloscope
3. Signal generator (Pattern generator) [NTSC] [PAL-M] [PAL-N]
4. Remote control unit
5. TV audio multiplex signal generator
6. Frequency counter

ADJUSTMENT ITEMS

- B1 POWER SUPPLY
- IF VCO adjustment
- RF AGC adjustment
- FOCUS adjustment
- DEFLECTION adjustment
 - V. HEIGHT, V. POSITION, V. LIN., V S CR adjustment
 - H. POSITION adjustment
- VIDEO / CHROMA adjustment
 - WHITE BALANCE (Low light) adjustment
 - WHITE BALANCE (High light) adjustment
 - SUB BRIGHT adjustment
 - SUB CONTRAST adjustment
 - SUB COLOR adjustment
 - SUB TINT adjustment
- MTS circuit adjustment (AV-20N31 ONLY)
 - INPUT LEVEL adjustment
 - STEREO VCO adjustment
 - SAP VCO adjustment
 - FILTER check
 - SEPARATION adjustment
- PURITY / CONVERGENCE adjustment
 - PURITY adjustment.
 - STATIC CONVERGENCE adjustment
 - DYNAMIC CONVERGENCE adjustment
- HOW TO CHECK THE HIGH VOLTAGE HOLD DOWN CIRCUIT.
- SELF CHECK FUNCTIONS

ADJUSTMENT LOCATIONS

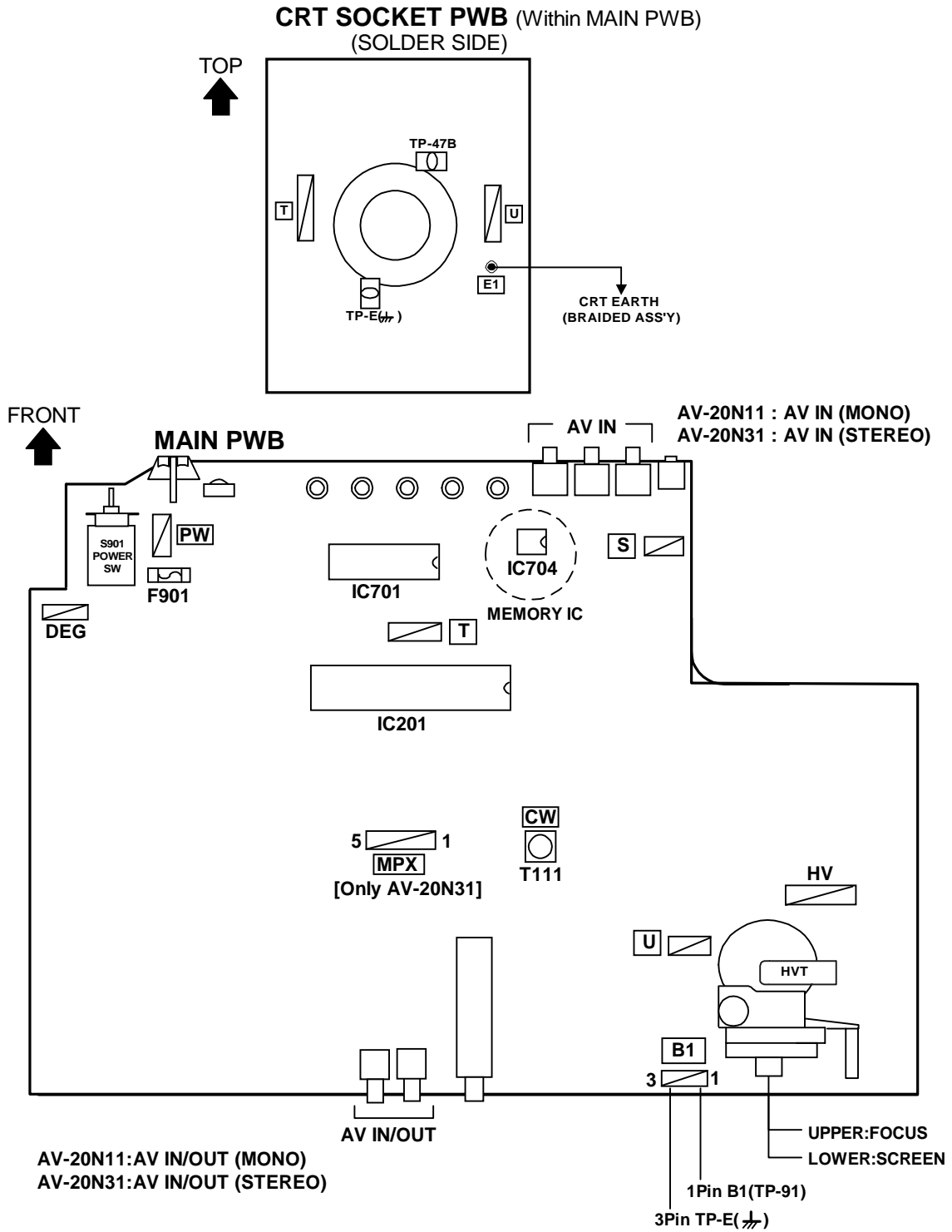

BASIC OPERATION IN SERVICE MENU

1. TOOL OF SERVICE MENU OPERATION

Operate the SERVICE MENU with the REMOTE CONTROL UNIT.

2. SERVICE MENU ITEMS

In general basic setting (adjustments) items or verifications are performed in the SERVICE MENU.

- (1) PICTURE This set the setting values (adjustment values) of the VIDEO/CHROMA and DEFLECTION circuits.
- (2) SOUND [AV-20N31 Only] This set the setting values (adjustment values) of the AUDIO circuit.
- (3) VIDEO STATUS This is used when the THEATER and GAME MODE is adjusted.
- (4) OTHERS This is used when the OTHERS MODE is adjusted.
- (5) LOW LIGHT..... This sets the setting values (adjustment values) of the WHITE BALANCE circuit.
- (6) HIGH LIGHT This sets the setting values (adjustment values) of the WHITE BALANCE circuit.
- (7) RF AFC CHK..... This is used when the RF AFC CHK MODE is verified. **[Do not adjust]**
- (8) VCO (CW) This is used when the IF VCO is adjusted.
- (9) I²C BUS CTRL..... This is used when ON/OFF of the I²C BUS CTRL is set. **[Fixed ON]**

3. Basic Operations of the SERVICE MENU

(1) How to enter the SERVICE MENU.

Press the DISPLAY key and VIDEO STATUS key of the remote control unit at the same time to enter the SERVICE MENU screen ① shown in figure page later.

(2) SERVICE MENU screen selection

Press the UP / DOWN key of the MENU to select any of the following items.

● PICTURE	● SOUND [AV- 20N31 Only]
● VIDEO STATUS	● OTHERS
● LOW LIGHT	● HIGH LIGHT
● RF AFC CHK	
● VCO (CW)	● I ² C BUS CTRL

(3) Enter the any setting (adjustment) mode

● PICTURE, SOUND and OTHERS mode

- 1) If select any of PICTURE, SOUND or OTHERS items, and the LEFT / RIGHT key is pressed from SERVICE MENU (MAIN MENU), the screen ② will be displayed as shown in figure page later.
- 2) Then the UP / DOWN key is pressed, the PICTURE mode screen ③ or the SOUND mode screen ④ or the OTHERS mode screen ⑤ is displayed, and the PICTURE, SOUND or OTHERS setting can be performed.

● VIDEO STATUS, LOW LIGHT, HIGH LIGHT, RF AFC CHK, VCO (CW) and I²C BUS CTRL mode

- 1) If select any of VIDEO STATUS / LOW LIGHT / HIGH LIGHT / RF AFC CHK / VCO (CW) / I²C BUS CTRL items, and the LEFT / RIGHT key is pressed from SERVICE MENU (MAIN MENU), the screens ⑥ ⑦ ⑧ ⑨ ⑩ ⑪ will be displayed as shown in figure page later.
- 2) Then the settings or verifications can be performed.

NOTE : In each menu screen , key operation guide will appear at the bottom, which will help your menu operation.

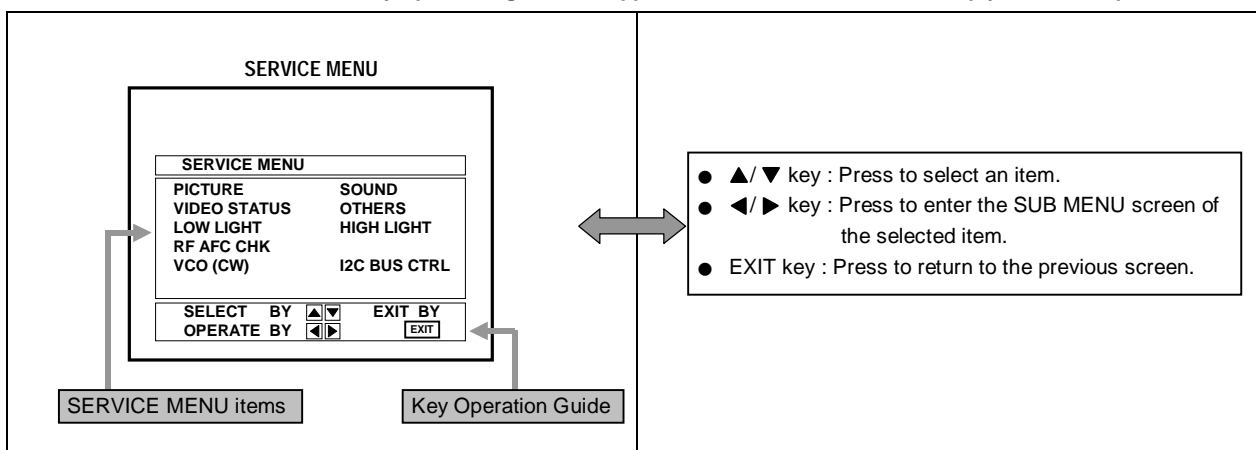

SERVICE MENU CHART

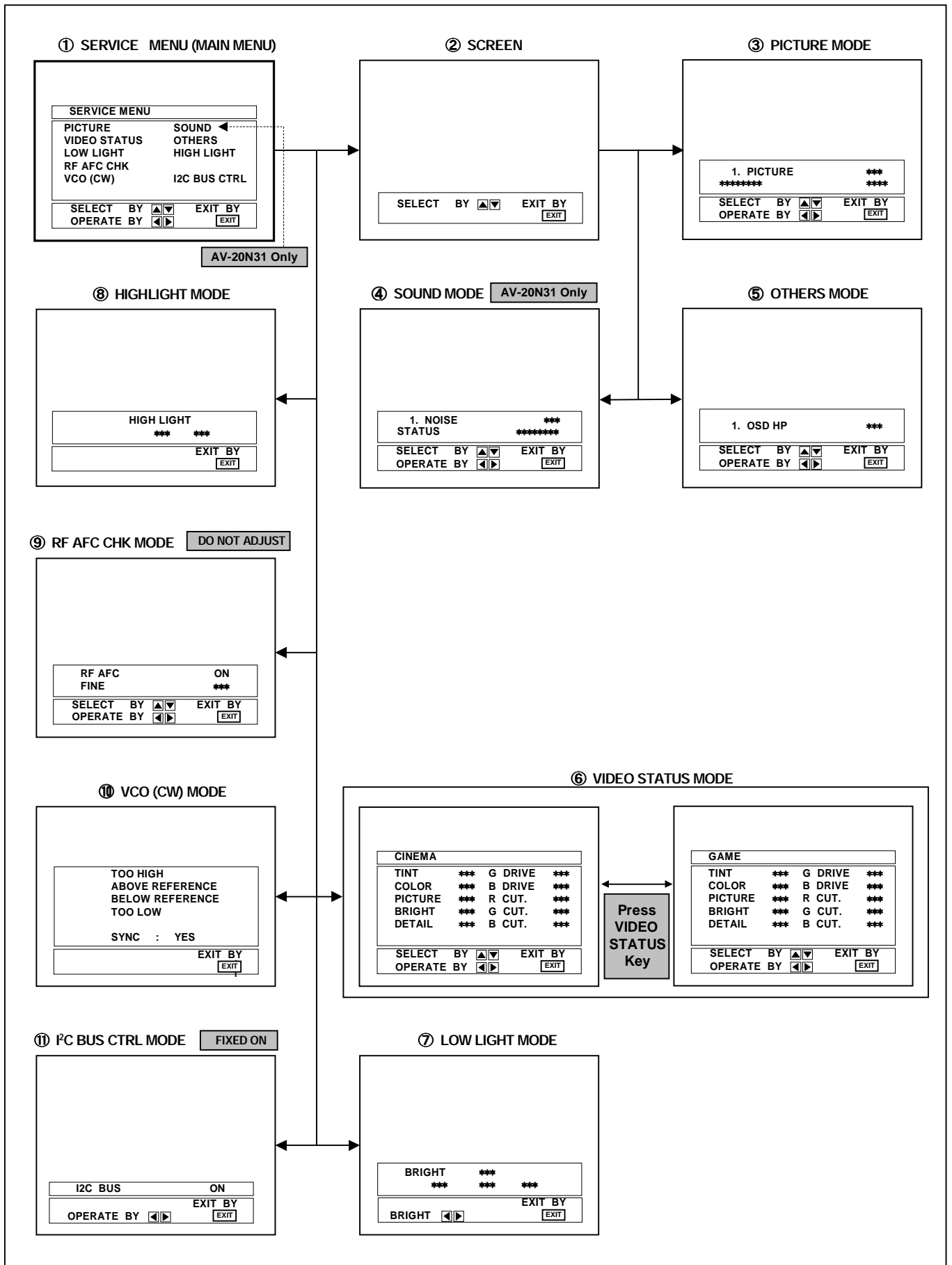

(4) Setting method

- 1) UP / DOWN key of the MENU
Select the SETTING ITEM.
- 2) LEFT / RIGHT key of the MENU
Setting (adjust) the SETTING VALUE of the SETTING ITEM.
When the key is released the SETTING VALUE will be stored (memorized).
- 3) EXIT key
Returns to the previous screen.

[NOTE] (PICTURE MODE ONLY)

When the INITIAL SETTING VALUE is turned to yellow, you can adjust the values but you cannot adjust the values when it is turned to red.
(Because the signal conditions, etc. are not met.)

(5) Releasing SERVICE MENU

- 1) After returning to the SERVICE MENU upon completion of the setting (adjustment) work, press the EXIT key again.

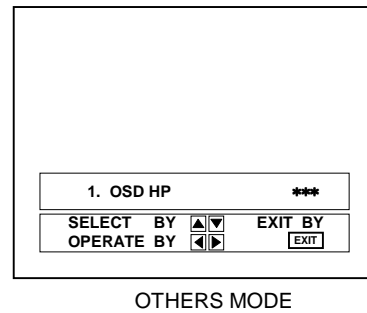
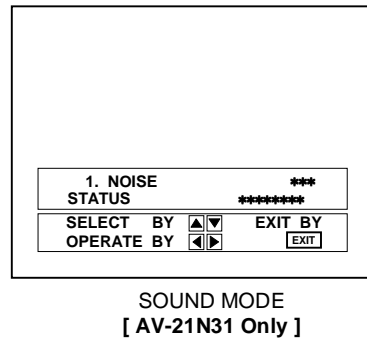
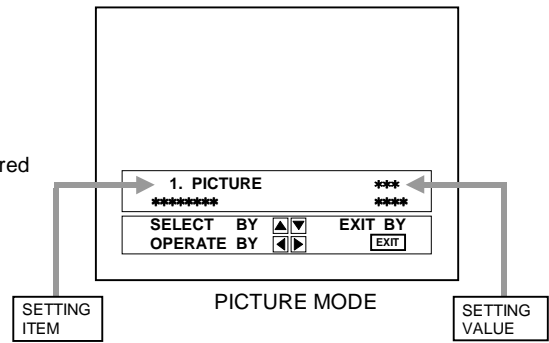

★ The settings for LOW LIGHT and HIGH LIGHT are described in the WHITE BALANCE page of ADJUSTMENT.

★ The setting for VCO (CW) are described in the IF VCO page of ADJUSTMENT.

(The letter of the selected items are displayed in yellow.)

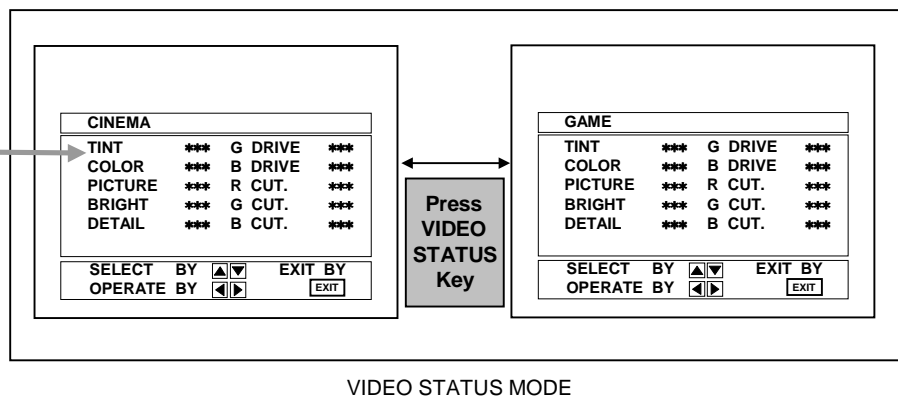

INITIAL SETTING VALUE OF SERVICE MENU

1. Adjustment of the SERVICE MENU is made on the basis of the initial setting values; however, the new setting values which set the screen in its optimum condition may differ from the initial setting.
2. Do not change the initial Setting Values of the Setting (Adjustment) items not listed in "ADJUSTMENT".
3. : Do not adjust in this area.

● PICTURE MODE (1/2)

- The four setting items in the video mode No.8 EXT PIC., No.9 EXT BRI., No.10 EXT COL. and No.11 EXT TINT are linked to the items in the TV MODE No.1 PICTURE, No.2 BRIGHT, No.5 COL. NTSC and No.6 TINT, respectively. When the setting items in the TV mode are adjusted, the values in the setting items in the video mode are revised automatically to the same values in the TV mode.(The initial setting values given in () are off-set values.)
- When the four items (No.8, 9, 10 and 11) are adjusted in the video mode, the setting values in each item are revised independently.

No.	Setting (Adjustment) item	Variable range	Initial setting value	
			AV-20N11	AV-20N31
1.	PICTURE	000~127	070	070
2.	BRIGHT	000~127	060	064
3.	COL. PALM	000~127	070	070
4.	COL. PALN	000~127	070	070
5.	COL. NTSC	000~127	072	072
6.	TINT	000~127	065	065
7.	TV DTL	000~063	033	033
8.	EXT PIC.	±025	(±000)	(±000)
9.	EXT BRI.	±025	(+005)	(+005)
10.	EXT COL.	±025	(±000)	(±000)
11.	EXT TINT	±025	(+001)	(+001)
12.	EXT DTL	000~063	035	035
13.	P/N KILL	000 / 001	001	001
14.	Y S CONT	000~031	031	031
15.	TV Y-DL	000~007	001	001
16.	EXT Y-DL	000~007	002	002
17.	WPL SW	000 / 001	000	000
18.	Y GAMMA	000 / 001	000	000
19.	P/N G P.	000 / 001	000	000
20.	COL. L SW	000 / 001	001	001
21.	COL. LMT.	000~003	001	001
22.	PN C. ATT	000~003	001	001
23.	OFST. SW	000 / 001	000	000
24.	OFST. B-Y	000~015	008	008
25.	OFST. R-Y	000~015	008	008
26.	C-TOF SW	000 / 001	001	001
27.	TV T FO	000~003	001	001
28.	TV T Q	000~003	000	000
29.	EXT T FO	000~003	000	000
30.	EXT T Q	000~003	000	000
31.	C-TRAP	000 / 001	000	000
32.	C-TR. FO	000~003	002	002
33.	C-TRAP Q	000~003	000	000
34.	FIX B/W	000 / 001	000	000
35.	APA P. FO	000~003	001	001
36.	DC TRAN.	000~007	007	007
37.	B. ST. SW	000 / 001	000	000
38.	B. ST. PO.	000~007	000	000
39.	ABL GAIN	000~007	004	004
40.	ABL PO.	000~007	000	000

● PICTURE MODE (2/2)

No.	Setting (Adjustment) item	Variable range	Initial setting value	
			AV-20N11	AV-20N31
41.	HALF T.	000~002	001	001
42.	DRV G SW	000 / 001	000	000
43.	NT. COMB	000 / 001	001	001
44.	COIN DET	000~003	001	001
45.	NOISE L.	000~003	003	003
46.	VCD MODE	000 / 001	000	000
47.	V AGC SP	000 / 001	000	000
48.	H POS. 50	000~031	007	007
49.	H BLK. 50	000~007	000	000
50.	V POS. 50	000~007	000	000
51.	V SIZE50	000~127	080	087
52.	V S CR50	000~127	028	028
53.	V LIN. 50	000~031	004	004
54.	H POS. 60	000~031	012	012
55.	H BLK. 60	000~007	000	000
56.	V POS. 60	000~007	000	000
57.	V SIZE60	000~127	082	088
58.	V S CR60	000~127	048	048
59.	V LIN. 60	000~031	003	004
60.	RF AGC	000~255	183	183

● SOUND MODE [AV-20N31 Only]

No.	Setting (Adjustment) item	Variable range	Initial setting value
1.	NOISE	000 / 001	001
2.	IN LEVEL	000~063	020
3.	FH MON.	000 / 001	000
4.	ST VCO	000~063	025
5.	PILOT	000 / 001	000
6.	FILTER	000~063	030
7.	LOW SEP.	000~063	022
8.	HI SEP.	000~063	023
9.	5FH MON.	000 / 001	000
10.	SAP VCO	000~063	026
11.	IN GAIN	000 / 001	000
12.	FIL. OFF.	±010	±000

● VIDEO STATUS MODE

Setting (Adjustment) item	Variable range	Initial setting value	
		CINEMA	GAME
TINT	±20	(±0)	(±0)
COLOR	±20	-3	-3
PICTURE	-30~+20	-10	-10
BRIGHT	±20	(±0)	(±0)
DETAIL	±15	(±0)	-5
G DRIVE	-99~+50	-22	(±0)
B DRIVE	-99~+50	-54	(±0)
R CUT.	±10	(±0)	(±0)
G CUT.	±10	(±0)	(±0)
B CUT.	±10	(±0)	(±0)

● OTHERS MODE

No.	Setting (Adjustment) item	Variable range	Initial setting value
1.	OSD HP	000~031	023
2.	OSD VP	000~015	012
3.	H-CK SW	000 / 001	000

● LOW LIGHT MODE

Setting (Adjustment) item	Variable range	Initial setting value
R CUTOFF	000~255	020
G CUTOFF	000~255	020
B CUTOFF	000~255	020

● HIGH LIGHT MODE

Setting (Adjustment) item	Variable range	Initial setting value
G DRIVE	000~255	128
B DRIVE	000~255	128

● RF AFC CHK MODE

Setting (Adjustment) item	Variable range	Initial setting value
RF AFC FINE	ON / OFF -77~+77	ON ± * * (DO NOT ADJUST)

● I²C BUS CTRL MODE

Setting (Adjustment) item	Variable range	Initial setting value
I ² C BUS	ON / OFF	[Fixed ON]

■ ADJUSTMENTS

B1 POWER SUPPLY

Item	Measuring instrument	Test point	Adjustment item	Description
Check of B1 POWER SUPPLY	DC Voltmeter	B1 (<input type="checkbox"/> B1 Connector <input type="checkbox"/> 1 pin) (TP-91) TP-E(↔) (<input type="checkbox"/> B1 Connector <input type="checkbox"/> 3 pin)		<ol style="list-style-type: none"> 1. Receive a black and white signal (color off). (NTSC) 2. Connect a DC voltmeter to TP-91(B1) and TP-E(↔). 3. Confirm that the voltage is DC134.5V±2V.

IF VCO ADJUSTMENT

Item	Measuring instrument	Test point	Adjustment item	Description
IF VCO adjustment	Signal generator		CW TRANSF. (T111) [VCO (CW)] mode	<ul style="list-style-type: none"> ● Under normal conditions, no adjustment is required. <ol style="list-style-type: none"> 1. Receive a broadcast. (use channels without offset frequency). 2. Select the VCO(CW) mode from the SERVICE MENU. 3. Confirm the color change (yellow) from TOO HIGH to TOO LOW by CW TRANSF. and SYNC : YES being shown on the screen. Then, adjust CW TRANSF. until BELOW REFERENCE mark turns yellow and confirm again SYNC : YES being shown on the screen.

The screenshot shows a menu with the following text:

TOO HIGH

ABOVE REFERENCE

BELOW REFERENCE ← YELLOW

TOO LOW

SYNC : YES

EXIT BY

EXIT

RF AGC ADJUSTMENT

RF AGC adjustment			No.60 RF AGC	<ol style="list-style-type: none"> 1. Receive a broadcast. 2. Select No.60 RF AGC of the PICTURE mode in SERVICE MENU. 3. Press the MUTE key and turn off color. 4. With the MENU LEFT key, get noise in the screen picture. (0 side of setting value) 5. Press the MENU RIGHT key and stop when noise disappears from the screen. 6. Change to other channels and make sure that there is no irregularity. 7. Press the MUTE key and get color out.
-------------------	--	--	--------------	---

FOCUS ADJUSTMENT

FOCUS adjustment	Signal generator		FOCUS VR [In HVT]	<ol style="list-style-type: none"> 1. Receive a crosshatch signal. 2. While looking at the screen, adjust FOCUS VR so that the vertical and horizontal lines will be clear and in fine detail. 3. Make sure that the picture is in focus even when the screen gets darkened.
------------------	------------------	--	-------------------	---

DEFLECTION ADJUSTMENT

Item	Measuring instrument	Test point	Adjustment item	Description
V. HEIGHT, V. POSITION, V. LIN. V. S CR adjustment	Signal generator		No.56 V POS. 60 No.57 V SIZE 60 No.58 V S CR60 No.59 V. LIN. 60	[60Hz] 1. Receive a crosshatch signal. (NTSC or PAL-M) 2. Confirm that the value of PICTURE MODE No.56 V POS. 60 is 0. 3. Confirm the initial setting value of the No.57 V SIZE 60, No.58 V S CR60 and No.59 V LIN. 60. 4. Adjust the vertical screen size to 92% with the PICTURE MODE No.57 V SIZE60. 5. Adjust the PICTURE MODE No.59 L LIN. 60 and No.58 V S CR60 to get the best vertical linearity. NOTE : The PICTURE MODE "No.56 V POS. 60" is fixed on value 0.
			No.50 V POS.50 No.51 V SISE 50 No.52 V S CR50 No.53 V LIN.50	[50Hz] 1. Receive a crosshatch signal. (PAL-N) 2. Confirm the initial setting value of the No.50 V POS.50, No.51 V SIZE 50 , No.52 V S CR 50 and No.53 V LIN.50. 3. Adjust the vertical screen size to 92% with the PICTURE MODE No.51 V SIZE50. 4. Adjust the PICTURE MODE No.53 V LIN.50 and No.52 V S CR50 to get the best vertical linearity. 5. Adjust the PICTURE MODE No.50 V POS.50 so that the vertical center line comes close to the CRT vertical center as much as possible. ● Readjust V SIZE, V LIN., V S CR if necessary.
H. POSITION adjustment	Signal generator		No.54 H POS.60	[60Hz] 1. Receive a crosshatch signal. (NTSC or PAL-M) 2. Select the No.54 H POS. 60 of the PICTURE mode in SERVICE MENU. 3. Confirm the initial setting value of the No.54 H POS. 60. 4. Adjust the No.54 H POS. 60 until the screen will be horizontally centered.
			No.48 H POS.50	[50Hz] 1. Receive a crosshatch signal. (PAL-N) 2. Select the No.48 H POS. 50 of the PICTURE mode in SERVICE MENU. 3. Confirm the initial setting value of the No.48 H POS. 50. 4. Adjust the No.48 H POS. 50 until the screen will be horizontally centered.

VIDEO / CHROMA ADJUSTMENT

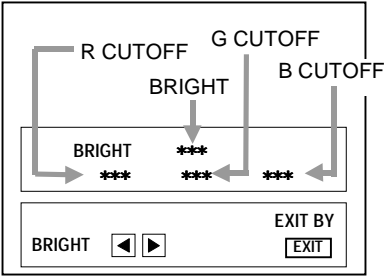
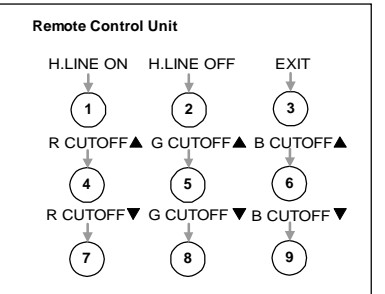
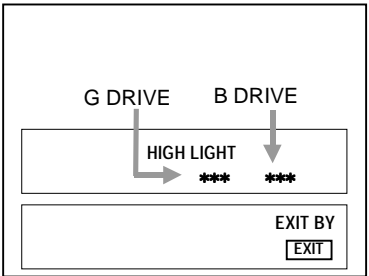
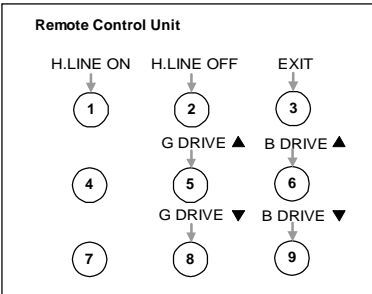
Item	Measuring instrument	Test point	Adjustment item	Description
<p>WHITE BALANCE (Low Light) adjustment</p>	<p>Signal Generator Remote control unit</p>		<p>BRIGHT R CUTOFF G CUTOFF B CUTOFF SCREEN VR</p>	<ol style="list-style-type: none"> 1. Receive a black and white signal (color off). 2. Select the LOW LIGHT mode from the SERVICE MENU. 3. Confirm the Initial setting value of BRIGHT, R CUTOFF, G CUTOFF and B CUTOFF. 4. Display a single horizontal line by pressing the ① key of the remote control unit. 5. Turn the screen VR all the way to the left. 6. Turn the screen VR gradually to the right from the left until either one of the red, blue or green colors appears faintly. 7. Adjust the two colors which did not appear until the single horizontal line that is displayed becomes white using the ④ to ⑨ keys of the remote control unit. 8. Turn the screen VR to where the single horizontal line glows faintly. 9. Press the ② key to return to the regular screen.
<p style="text-align: center;">[LOW LIGHT] MODE</p>  				
<p>WHITE BALANCE (High Light) adjustment</p>	<p>Signal Generator Remote control unit</p>		<p>G DRIVE B DRIVE</p>	<ol style="list-style-type: none"> 1. Receive a black and white signal (color off). 2. Select the HIGH LIGHT mode in the SERVICE MENU. 3. Confirm the initial setting value of G DRIVE and B DRIVE. 4. Adjust the screen color to white with the ⑤, ⑥, ⑧ and ⑨ keys of the remote control unit.
<p style="text-align: center;">[HIGH LIGHT] MODE</p>  				

Item	Measuring instrument	Test point	Adjustment item	Description
SUB BRIGHT adjustment	Remote control unit		No.2 BRIGHT	<ol style="list-style-type: none"> 1. Receive a broadcast. 2. Select No.2 BRIGHT of the PICTURE mode in SERVICE MENU. 3. Confirm the initial setting value of the No.2 BRIGHT. 4. If the brightness is not the best with the initial setting value, make fine adjustment of the No.2 BRIGHT until you get the optimum brightness.
SUB CONTRAST adjustment	Remote control unit		No.1 PICTURE	<ol style="list-style-type: none"> 1. Receive a broadcast. 2. Select No.1 PICTURE of the PICTURE mode in SERVICE MENU. 3. Confirm the initial setting value of the No.1 PICTURE. 4. If the contrast is not the best with the initial setting value, make fine adjustment of the No.1 PICTURE until you get the optimum contrast.
SUB COLOR adjustment [1]	Remote control unit		No.3 COL. PALM	[PAL-M] <ol style="list-style-type: none"> 1. Receive a PAL-M broadcast. 2. Select No.3 COL. PALM of the PICTURE mode in SERVICE MENU. 3. Confirm the initial setting value of the No.3 COL. PALM. 4. If the color is not the best with the initial setting value, make fine adjustment until you get the best color.
			No.4 COL. PALN	[PAL-N] <ol style="list-style-type: none"> 1. Receive a PAL-N broadcast. 2. Select No.4 COL. PALN of the PICTURE mode in SERVICE MENU. 3. Confirm the initial setting value of the No.4 COL. PALN. 4. If the color is not the best with the initial setting value, make fine adjustment until you get the best color.
			No.5 COL. NTSC	[NTSC] <ol style="list-style-type: none"> 1. Receive a NTSC broadcast. 2. Select No.5 COL. NTSC of the PICTURE mode in SERVICE MENU. 3. Confirm the initial setting value of the No.5 COL. NTSC. 4. If the color is not the best with the initial setting value, make fine adjustment until you get the best color.
SUB TINT adjustment [1]	Remote control unit		No. 6 TINT	<ol style="list-style-type: none"> 1. Receive a NTSC color bar signal. 2. Select No. 6 TINT of the PICTURE mode in SERVICE MENU. 3. Confirm the initial setting value of the No. 6 TINT. 4. If the tint is not the best with the initial setting value, make fine adjustment until you get the best tint.

Item	Measuring instrument	Test point	Adjustment item	Description
Adjustment of SUB COLOR- II	<ul style="list-style-type: none"> ● Signal generator ● Oscilloscope ● Remote control unit 	TP-47B TP-E(↕) [CRT SOCKET PWB]		[Method of adjustment using measuring instrument]
			3. COL. PALM	(PAL-M COLOR) <ol style="list-style-type: none"> 1. Receive a PAL-M full field color bar signal (75% white). 2. Select the sub menu screen PICTURE from the SERVICE MENU. 3. Select 3. COL. PALM with the MENU ▲/▼ key , and confirm its initial setting value. 4. Connect the oscilloscope between TP-47B and TP-E. 5. Adjust 3. COL. PALM to set the value (A) in the figure to +3V (W & B), with the MENU ◀/▶ key.
			4. COL. PALM	(PAL-N COLOR) <ol style="list-style-type: none"> 1. Receive a PAL-N full field color bar signal (75% white). 2. In the sub menu screen PICTURE, select 4. COL. PALN with the MENU ▲/▼ key, and confirm its initial setting value. 3. Connect the oscilloscope between TP-47B and TP-E. 4. Adjust 4. COL. PALN to set the value (A) in the figure to +11V(W & B), with the MENU ◀/▶ key.
5. COL. NTSC	(NTSC COLOR) <ol style="list-style-type: none"> 1. Receive a NTSC full field color bar signal (75% white). 2. In the sub menu screen PICTURE, select 5. COL. NTSC with the MENU ▲/▼ key, and confirm its initial setting value. 3. Connect the oscilloscope between TP-47B and TP-E. 4. Adjust 5. COL. NTSC to set the value (A) in the figure to +13V(W & B), with the MENU ◀/▶ key. 			
Adjustment of SUB SUB TINT- II	<ul style="list-style-type: none"> ● Signal generator ● Oscilloscope ● Remote control unit 	TP-47B TP-E(↕) [CRT SOCKET PWB]		[Method of adjustment using measuring instrument]
			6.TINT	<ol style="list-style-type: none"> 1. Receive a NTSC 3.58 color bar signal (full field color bar 75%white). 2. Select the sub menu screen PICTURE from the SERVICE MENU. 3. Select 6. TINT with the MENU ▲/▼ key, and confirm its initial setting value. 4. Connect the oscilloscope betweenTP-47B and TP-E. 5. Adjust 6. TINT to set the value (B) in the figure to +14V(W & Mg), with the MENU ◀/▶ key.

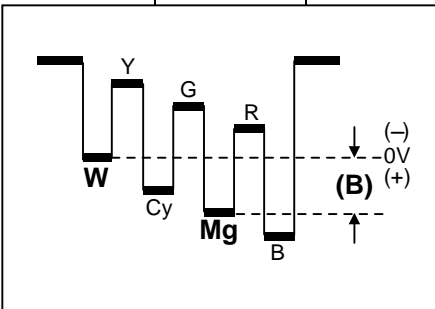
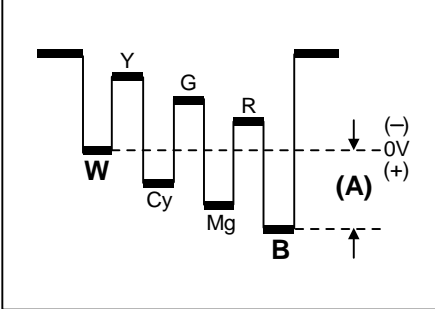

VIDEO STATUS ADJUSTMENT (Do not adjust. Each value should be set to the initial value.)

Item	Measuring instrument	Test point	Adjustment item	Description
<p>Setting of VIDEO STATUS</p>	<p>Remote control unit</p>		<p>TINT COLOR PICTURE BRIGHT DETAIL G DRIVE B DRIVE R CUT. G CUT. B CUT.</p>	<ol style="list-style-type: none"> 1. Select the sub menu screen VIDEO ST ATUS-CINEMA from the SERVICE MENU. 2. Select TINT ~ B CUT. with the MENU ▲/▼ key, and reset each value to the initial setting value on page before, with the MENU ◀/▶ key. 3. Press the VIDEO STATUS key on the remote control unit to select VIDEO STATUS-GAME. (Each time you press the VIDEO STATUS key, CINEMA and GAME alternates.) 4. Make similar settings as in 2 above.

SUB MENU : VIDEO STATUS

GAME			
TINT	***	G DRIVE	***
COLOR	***	B DRIVE	***
PICTURE	***	R CUT.	***
BRIGHT	***	G CUT.	***
DETAIL	***	B CUT.	***

SELECT BY ▲▼ EXIT BY
 OPERATE BY ◀▶ EXIT

MTS ADJUSTMENT [AV-20N31 Only]

Item	Measuring instrument	Test point	Adjustment part	Description
INPUT LEVEL check			No.2 IN LEVEL	<ol style="list-style-type: none"> 1. Select the No.2 IN LEVEL of the SOUND mode in SERVICE MENU. 2. Verify that the No.2 IN LEVEL is set at its initial setting value.
STEREO VCO adjustment	Signal generator Frequency counter	R OUT [AUDIO OUT]	No.3 FH MON No.4 ST VCO	<ol style="list-style-type: none"> 1. Receive a NTSC RF signal (non modulated sound signal) from the antenna terminal. 2. Select the No.3 FH MON of SOUND mode in SERVICE MENU, change the setting value from 0 to 1. 3. Connect the frequency connector to R OUT RCA pin of the AUDIO OUT. 4. Select the No.4 ST VCO. 5. Confirm the initial setting value of the No.4 ST VCO. 6. Adjust the No.4 ST VCO so that the frequency counter will display $15.73\text{kHz} \pm 0.1\text{kHz}$. 7. Select the No.3 FH MON of the SOUND mode, and reset the setting value from 1 to 0.
SAP VCO adjustment	Signal generator Frequency counter	<div style="border: 1px solid black; padding: 2px; width: fit-content;">MPX Connector</div> <div style="border: 1px solid black; padding: 2px; width: fit-content;">4 pin SDA</div> <div style="border: 1px solid black; padding: 2px; width: fit-content;">3 pin GND</div> <div style="border: 1px solid black; padding: 2px; width: fit-content;">[MAIN PWB]</div> R OUT [AUDIO OUT]	No.9 5FH MON. No.10 SAP VCO.	<ol style="list-style-type: none"> 1. Receive a NTSC RF signal (non modulated sound signal) from the antenna terminal. 2. Connect between pin 4 of MPX connector and GND (pin 3 of MPX connector) through $1\text{M}\Omega$ resistor. 3. Select the No.9 5FH MON. of the SOUND mode in SERVICE MENU, and reset the setting value from 0 to 1. 4. Connect the frequency connector to R OUT RCA pin of the AUDIO OUT. 5. Select the No.10 SAP VCO. 6. Confirm the initial setting value of No.10 SAP VCO. 7. Adjust the No.10 SAP VCO so that the frequency connector will display $78.67\text{kHz} \pm 0.5\text{kHz}$. 8. Select the No.9 5FH MON. of the SOUND mode, and reset the setting value from 1 to 0.
FILTER check			No.6 FILTER	<ol style="list-style-type: none"> 1. Select the No.6 FILTER of the SOUND mode in SERVICE MENU. 2. Verify that the No.6 FILTER is set at its initial setting value.
SEPARATION adjustment	TV audio multiplex signal generator Oscilloscope	L OUT R OUT [AUDIO OUT]	No.7 LOW SEP. No.8 HI SEP.	<ol style="list-style-type: none"> 1. Input a stereo L signal (300Hz) from the TV Audio multiplex signal generator to the antenna terminal. (NTSC) 2. Connect an oscilloscope to L OUT RCA pin of the AUDIO OUT, and display one cycle portion of the 300Hz signal. 3. Change the connection of the oscilloscope to R OUT RCA pin of the AUDIO OUT, and enlarge the voltage axis. 4. Select the No.7 LOW SEP. of the SOUND mode in SERVICE MENU. 5. Confirm the initial setting value of the No.7 LOW SEP. 6. Adjust the No.7 LOW SEP. so that the stroke element of the 300Hz signal will become minimum. 7. Change the signal to 3kHz, and similarly adjust the No.8 HI SEP.

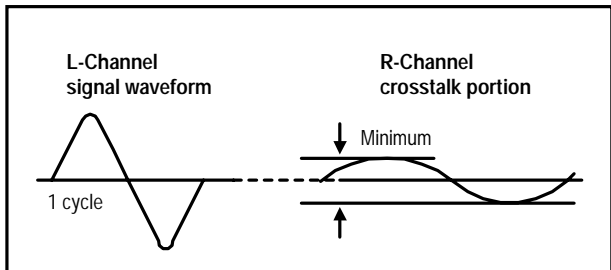

PURITY / CONVERGENCE ADJUSTMENT

PURITY ADJUSTMENT

1. Demagnetize CRT with the demagnetizer.
2. Loosen the retainer screw of the deflection yoke.
3. Remove the wedges.
4. Input a green raster signal from the signal generator, and turn the screen to green raster.
5. Move the deflection yoke backward.
6. Bring the long lug of the purity magnets on the short lug and position them horizontally. (Fig.2)
7. Adjust the gap between two lugs so that the GREEN RASTER will come into the center of the screen. (Fig.3)
8. Move the deflection yoke forward, and fix the position of the deflection yoke so that the whole screen will become green.
9. Insert the wedge to the top side of the deflection yoke so that it will not move.
10. Input a crosshatch signal.
11. Verify that the screen is horizontal.
12. Input red and blue raster signals, and make sure that purity is properly adjusted.

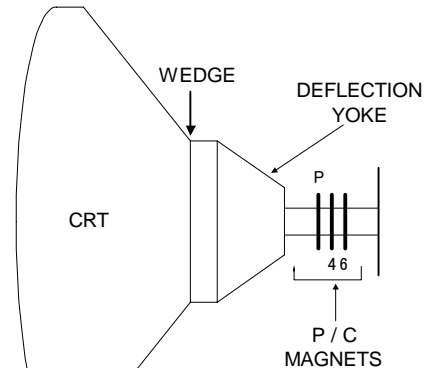

• P/C MAGNETS

P : PURITY MAGNET
4 : 4 POLES (convergence magnets)
6 : 6 POLES (convergence magnets)

Fig.1

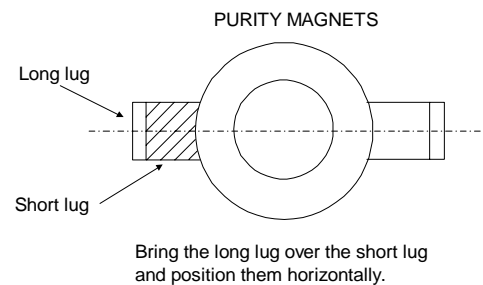

Fig.2

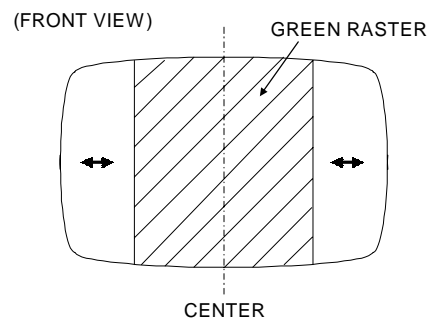

Fig.3

STATIC CONVERGENCE ADJUSTMENT

1. Input a crosshatch signal.
2. Using 4-pole convergence magnets, overlap the red and blue lines in the center of the screen (Fig.1) and turn them to magenta (red/blue).
3. Using 6-pole convergence magnets, overlap the magenta(red/blue) and green lines in the center of the screen and turn them to white.
4. Repeat 2 and 3 above, and make best convergence.

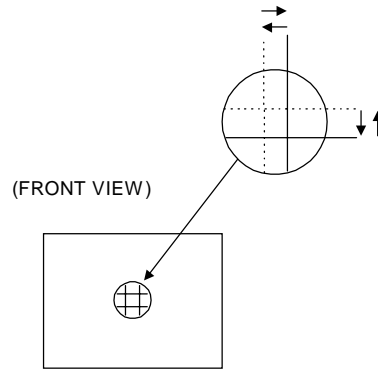

Fig.1

DYNAMIC CONVERGENCE ADJUSTMENT

1. Move the deflection yoke up and down and overlap the lines in the periphery. (Fig. 2)
 2. Move the deflection yoke left to right and overlap the lines in the periphery. (Fig. 3)
 3. Repeat 1 and 2 above, and make best convergence.
- After adjustment, fix the wedge at the original position.
Fasten the retainer screw of the deflection yoke.
Fix the 6 magnets with glue.

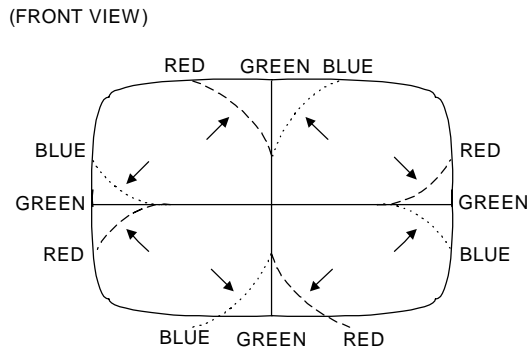

Fig.2

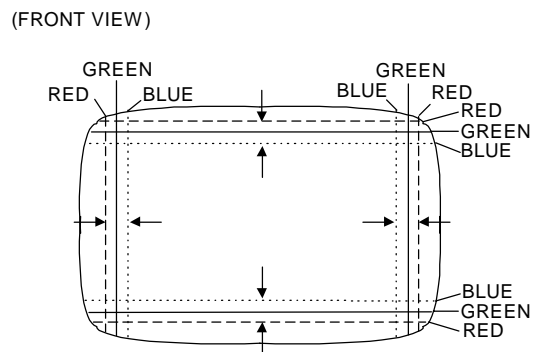

Fig.3

SELF CHECK FUNCTIONS

1. Outline

This model includes protector functions for Over-current, X-ray and CRT NECK which cutoff the sub-power in the event of a malfunction and inform of the malfunction by flashing ON TIMER LED.

The malfunction is detected according to the state of the control line input connected to the main CPU.

2. Self check items

Check item	Detected contents	Detection method	Abnormality state
Over-current protector	An over-current on the B1 line and Audio-Vcc line is detected. [AV-20N11] An over-current on the B1 line is detected. [AV-20N31]	The main CPU detects at 1 second intervals. If NG is detected for more than 1 ms, a malfunction is interpreted.	During an abnormality the sub-power is cutoff. The remote controller power key operation is not recognized and sub-power off is maintained until the power cord is unplugged and reinserted.
X-ray protector	Operation of X-ray protection circuit	The main CPU detects at 1 second intervals. If NG is detected for more than 1 ms, a malfunction is interpreted.	During an abnormality the sub-power is cutoff. The remote controller power key operation is not recognized and sub-power off is maintained until the power cord is unplugged and reinserted.
CRT NECK protector	When the vertical circuit S-correction capacitor C413 is shorted, detect the potential drop of the C413, and prevent the burn damage to the CRT NECK.	The main CPU detects at 1 second intervals. If NG is detected for more than 1 ms, a malfunction is interpreted.	During an abnormality the sub-power is cutoff. The remote controller power key operation is not recognized and sub-power off is maintained until the power cord is unplugged and reinserted.

3. Self check indicating function

The self check function begins detection about 5 seconds after power is supplied.

In the event a malfunction is detected, the sub-power is cutoff immediately.

At this time, the ON TIMER LED flashes to inform of the malfunction.

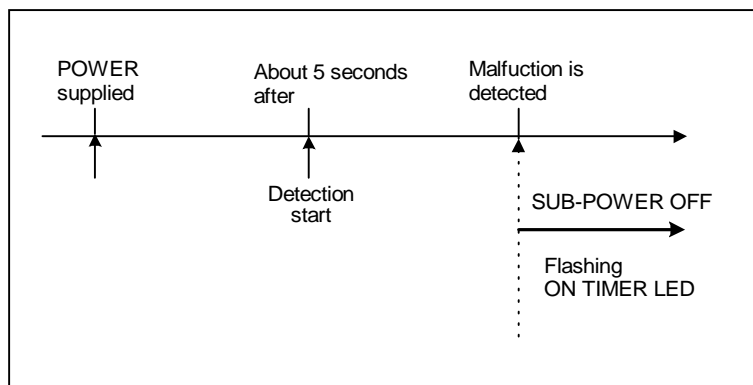

Item	LED ON/OFF intervals	Priority of detection
OCP/X-ray	every 0.5-second.	1
NECK	every 1.0-second.	2